

# SCALANT



**DE** Montageanleitung Außentreppe Scarvo

**EN** Instructions external staircase Scarvo

**FR** Instructions d'installation escalier extérieur Scarvo

**ES** Instrucciones de montaje de la escalera exterior Scarvo



## Inhaltverzeichnis

1. Notwendige Vorarbeiten	3
2. Stückliste	4-6
3. Berechnung des Stufenabstandes	7
4. Montagehinweis für Treppen ab 15 Steigungen	8
5. Montage	9-20

---



## Table of Contents

1. Required preliminary work	21
2. Scarvo Outside Staircase parts list	22-24
3. Calculation of step spacing	25
4. Assembly note for staircases of 15 steps or more	26
5. Assembly	27-38

---



## Sommaire

1. Préparatifs nécessaires	39
2. Liste des pièces pour l'escalier extérieur Scarvo	40-42
3. Calcul des hauteurs de marche	43
4. Conseils de montage pour un escalier de plus de 15 marches	44
5. Montage	45-56

---



## Índice

1. Trabajos previos necesarios	57
2. Lista de piezas - escalera exterior Scarvo	58-60
3. Cálculo de la distancia entre escalones	61
4. Instrucciones de montaje para escaleras a partir de 15 escalones	62
5. Montaje	63-74

---



# Montageanleitung Außentreppe Scarvo

## 1) Notwendige Vorarbeiten

Die Fundament-Angaben entsprechen normalen Bodenverhältnissen bei gewachsenem Erdreich.

Betonmaterial: Bn25

Frostfrei gegründet (ca.80 cm) auf gewachsenem Boden!

### Abmaße Fundament:

	<b>Ø 130</b>	<b>Ø 160</b>	<b>Ø 180</b>	<b>Ø 225</b>
<b>S</b>	40x40x80 cm	40x40x80 cm	40x40x80 cm	40x40x80 cm
<b>M</b>	55x55x80 cm	55x55x80 cm	55x55x80 cm	55x55x80 cm















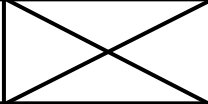



### Hilfsmittel zur Montage der Außentreppe:

- (Schlag-)Bohrmaschine, Akku-Schrauber
- Schraubendreher (Torx)
- Innensechskantschlüssel (z.B. Inbus) 3 mm, 4 mm, 5 mm
- Bandmaß, Taschenrechner
- Hammer, Kombizange
- Schraubenschlüssel SW10 mm
- Wasserwaage
- Metallsäge
- Leiter



# Montageanleitung Außentreppe Scarvo















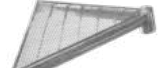

## 2) Stückliste Außentreppe Scarvo

#	Bezeichnung	Techn. Info	Abbildung	
			Standard	Premium
1.	Fußplatte mit Rohrmuffe			
2.	Ronde			
3.	Geländerstab gekröpft			
4.1.	Schraube A2 Halbrundkopf	6x25 mm		
4.2.	Senkkopfschraube	M6x16 mm		
5.	Gewindestift	M8x8 mm		
6.	Handlaufverbinder			
7.	Geländerfuß			
8.	Sockel für Podeststab			
9.	Zentralstandrohr			
10.	Spannhülse A2			
11.	Handlaufhalter			
12.	Schraube A2 Linsenkopf	4,8x13 mm		
13.	Gewindestift	M6x5 mm		
14.	Handlauf-Podest			



# Montageanleitung Außentreppe Scarvo

## 2) Stückliste Außentreppe Scarvo

#	Bezeichnung	Techn. Info	Abbildung	
			Standard	Premium
15.	Universalanschluss			
16.	Geländerstab gerade			
17.	Abschlussrohr oben			
18.	Podeste mit Streckgitter			
19.	Stufen mit Streckgitter			
20.	Schraube A2 Senkkopf	4,8x16 mm		
21.	Rohrstopfen Geländerstab	Ø20 mm		
22.	Handlauf-Rohrbogensegment	Ø40 mm		
23.	Handlaufrohr Endstopfen	Ø40 mm		
24.	Bit	TORX 25		
25.	Zink-Alu Spray	400 ml		
26.	Gewindebohrer	M6 mm		
27.	Kabelbinder	2,6x100 mm		
28.	Spiralbohrer	Ø 4 mm Ø 5 mm		



# Montageanleitung Außentreppe Scarvo

## 2) Stückliste Außentreppe Scarvo

#	Bezeichnung	Techn. Info	Abbildung	
			Standard	Premium
29.	Sechskantschraube A2	Stahl: M6x35 mm WPC: M6x60 mm		
30.	Sechskantschraube A2	M6x50 mm		
31.	Gewindestift	10x8 mm		
32.	Standrohradapter			



# Montageanleitung Außentreppe Scarvo

## 3) Berechnung des Stufenabstands

Durch die unterschiedlichen Geschosshöhen muss die Stufenhöhe individuell berechnet werden. Messe die Geschosshöhe **H** von dem Fußboden bis zur Oberkante des Fußbodens der Deckenöffnung. Dividiere (:) die Geschosshöhe **H** durch die Anzahl der Stufen + Podest.

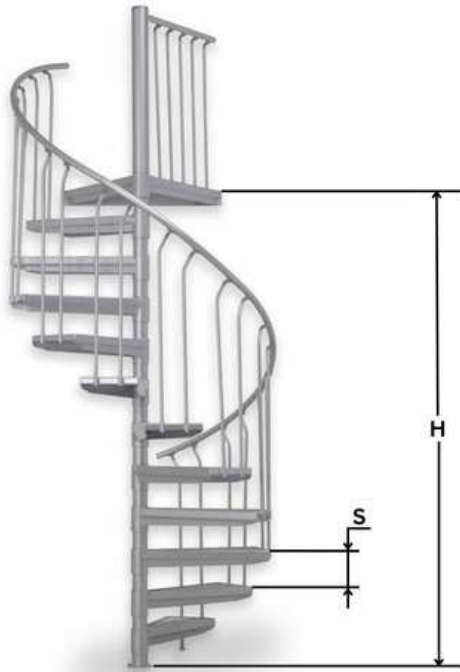

Beispiel:

$$S = \frac{H}{\text{Stufenanzahl} + \text{Podestanzahl}}$$

$$S = \frac{252 \text{ cm}}{11 \text{ Stufen} + 1 \text{ Podest}}$$

$$S = 21 \text{ cm}$$



Das Befestigungsmaterial für die Montage des Podestes an dem Gebäude und für die Montage der Fußplatte am Boden liegt nicht bei.

Bitte prüfe in regelmäßigen Abständen alle sich an der Wendeltreppe befindlichen Schraubverbindungen.

**Für Schäden, die durch unsachgemäße Montage entstehen, wird keine Haftung übernommen.**



# Montageanleitung Außentreppe Scarvo

## 4) Montagehinweis für Treppen ab 15 Steigungen

Bei Treppenhöhen über 284 cm wird das Standrohr durch eine Standrohrverlängerung auf das benötigte Höhenmaß gebracht, und mittels der beigelegten Gewindestifte (31) fest miteinander verschraubt. Die Standrohrverlängerung wird am oberen Ende 16-70cm über dem Podest abgetrennt. Dieser Überstand wird zur Befestigung des Abschlussrohres (17) benötigt. Der Rest des Verlängerungsrohres kann entsorgt werden.

Bei den Durchmessern 130-180 cm wird ab 21 Steigungen, das Standrohr durch ein weiteres Standrohr (9) auf das benötigte Höhenmaß gebracht. Zur Verbindung der beiden Standrohre wird der Standrohradapter (32) eingesetzt und mittels der beigelegten Gewindestifte (31) fest miteinander verschraubt. Das Verlängerungsstandrohr wird am oberen Ende 16-70 cm über dem Podest abgetrennt. Dieser Überstand wird zur Befestigung des Abschlussrohres (17) benötigt. Der Rest des Standrohres kann entsorgt werden.

Hinweis: Platz für den Handlauf

Bitte beachte, dass unsere Treppensysteme einen bündigen Handlauf zu unseren Stufen haben und somit der Handlauf direkt an die Hauswand trifft, wenn die Treppe eine ganze Wendelung macht.

Um dieses zu umgehen muss der Abstand des Standrohres von der Wand um zusätzliche 5-6 cm vergrößert werden. Hierfür kann unser entwickelter Podestadapter genutzt werden.

Bei einem Bauvorhaben mit Anbau an bspw. einem Balkon entfällt die Notwendigkeit des Podestadapters bei jeder Treppenhöhe.





# Montageanleitung Außentreppe Scarvo

## 5) Montage

### Schritt 1

Beginne damit das Fundament zu gießen. Die Maße des Fundaments kannst du der oben stehenden Tabelle (Seite 3) passend zu deiner Treppe entnehmen.

Um das Fundament im richtigen Abstand zur Wand zu gießen, entnehme die Maße passend zu deinem Durchmesser aus der Tabelle.

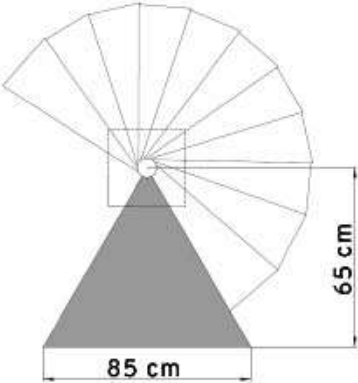
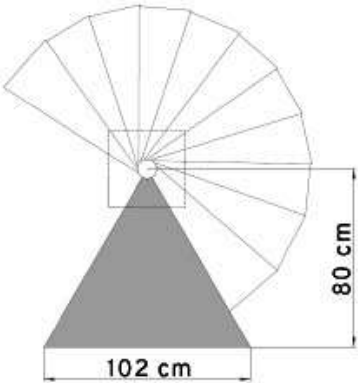
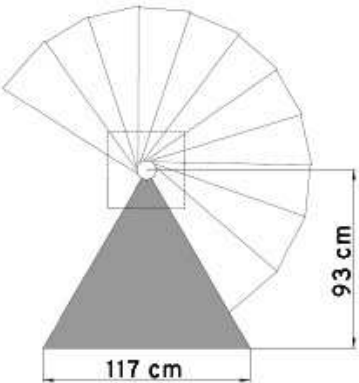
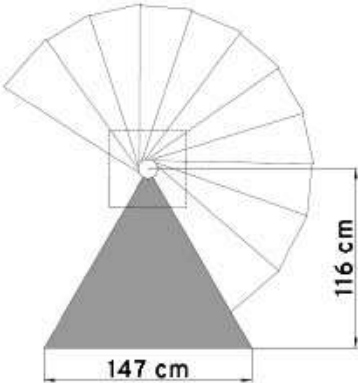
<b>Ø 130 cm</b>	<b>Ø 160 cm</b>
	
<b>Ø 180 cm</b>	<b>Ø 225 cm</b>
	



# Montageanleitung Außentreppe Scarvo

## 5) Montage

### Schritt 2

Zuerst wird die Fußplatte montiert. Um die Löcher an den richtigen Stellen zu bohren, sollte man die Fußplatte (1) auf das Fundament auflegen und die dort vorgegebenen Löcher mit einem Bleistift nachzeichnen (Bild 1). Bei der Ausrichtung der Fußplatte ist der passende Abstand zur Wand zu beachten. Die passenden Abstände entnehmen der Tabelle. (Seite 9)



### Schritt 3

Im zweiten Schritt muss die Fußplatte (1) auf dem Fundament befestigt werden (Bild 1). Im Anschluss stecke das Zentral-Standrohr (9) auf die am Boden befestigte Fußplatte und fixiere dies mit den mitgelieferten Gewindestiften (31) (Bild 2).

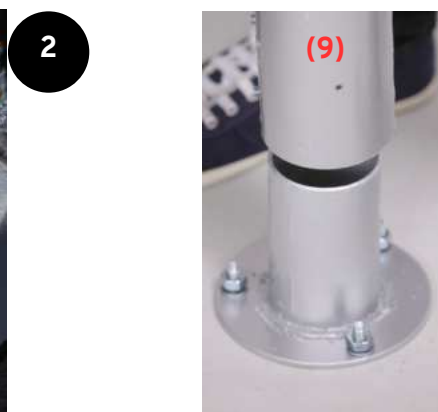



# Montageanleitung Außentreppe Scarvo

## 5) Montage

### Schritt 4

Wenn das Zentral-Standrohr steht, kann mit dem Auffädeln der Stufen (19) begonnen werden. Dafür schiebe die Stufen einfach auf das Standrohr übereinander (Bild 1). Um eine bessere Stabilität zu gewährleisten, benutze ein Hilfsmittel wie z.B. ein Kantholz und lege die erste Stufe auf das Kantholz (Bild 2).



### Schritt 5

Sind alle Stufen aufgefädelt, kann das Podest (18) auf das Zentral-Standrohr montiert werden. Dazu richte das Podest bündig mit der Oberkante des Fertigfußbodens aus und verschraube es mit der Wand (Bild 1). Anschließend richte das Podest mit einer Wasserwaage aus und befestige dieses an dem Zentral-Standrohr. Verwende dafür die mitgelieferten Gewindestifte (5) (Bild 2). Bitte beachte, dass du bei einer Holzdecke mindestens 10x60 mm Schlüsselschrauben und bei einer Betondecke Schwerlastdübel verwenden musst.





# Montageanleitung Außentreppe Scarvo

## 5) Montage

### Schritt 6

Im Anschluss müssen die einzelnen Stufenabstände markiert und die Stufen ausgerichtet werden. Orientierungslinien erleichtern das spätere Ausrichten der Stufen. Der Stufenabstand lässt sich ganz einfach ermitteln: Geschosshöhe H / (11 Stufen + 1 Podest). Die Fixierung eines Maßbandes am Standrohr vereinfacht die Arbeit ungemein (Bild 1). Fange mit der ersten Stufe von oben an. Lasse die Stufen am Stufenende 1 cm überlappen. Befestige die Stufen mit den Gewindestiften (5) (Bild 2). Diesen Schritt führe bei allen Stufen durch.



### Schritt 7

Nun werden zuerst die hinteren Geländerstäbe (3) in die Geländerhalter am Ende der Stufe eingesetzt (Bild 1). Befestige die Stäbe zunächst mit den Gewindestiften (13) (Bild 2). Die Kröpfung der Stäbe zeigt entgegen der Laufrichtung (von unten nach oben gesehen).

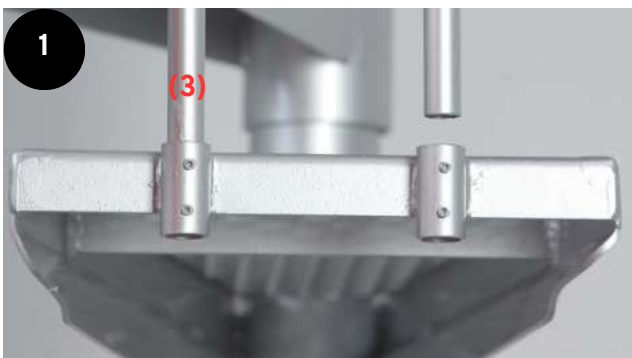





# Montageanleitung Außentreppe Scarvo

## 5) Montage

### Schritt 8

Setze nun die vorderen Geländerstäbe ein und lasse diese ca. 13 cm nach unten herausstehen. Befestige nun den Geländerfuß (7) an dem ersten Geländerstab (Bei der Scarvo S muss der Geländerfuß nicht montiert werden).

### Schritt 9

Verschraube die Teile des Handlaufhalters (11) mit der Schraube (4). Im Anschluss stecke den Handlaufhalter auf die Geländerstäbe.

1



2



### Schritt 10

Setze nun die Handlauf-Rohrbogensegmente (22) auf die Handlaufhalter und befestige diese provisorisch mit den mitgelieferten Kabelbindern (27) (Bild 1). Beginne von unten. Stecke die Handlaufsegmente mittels Handlaufverbinder (6) zusammen (Bild 2).

1



2





# Montageanleitung Außentreppe Scarvo

## 5) Montage

Nun richte die Laschen parallel zum Handlauf aus, indem du die Kugel in den Stab drehst. Durch das Verdrehen der Stange kann der Winkel der Lasche verändert werden (Bild 3).

**Wichtig:** Die Senkrechthaltung der Stäbe durch Anwendung einer Wasserwaage überprüfen (Bild 4).

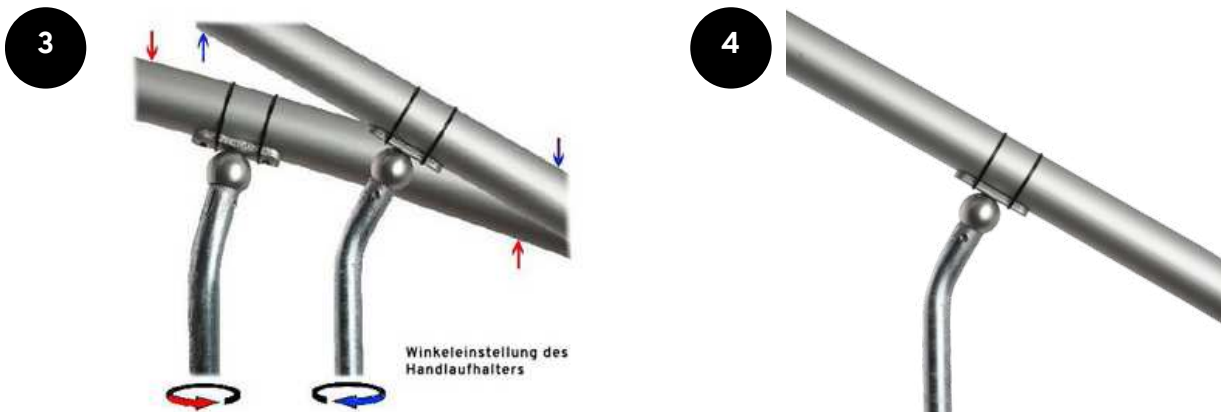

Wenn diese ausgerichtet sind, verschraube den Halter mit dem Geländerstab mit der Flachkopfschraube (12).

Im nächsten Schritt zeichne mit einem Bleistift die Löcher vor und bohre diese mit dem mitgelieferten Bohrer Ø4 mm (28) in den Handlauf. Anschließend nimm die Senkkopfschrauben (20) und verschraube den Handlaufhalter mit dem Handlaufrohr (Bild 5).





# Montageanleitung Außentreppe Scarvo

## 5) Montage

### Schritt 11

Wenn die Handläufe verschraubt sind, werden die Kabelbinder entfernt und die Gewindestifte, die an den Stufenenden die Geländerstäbe halten, nachgezogen (Bild 1).



### Schritt 12

Kürze den nach unten überstehenden Geländerstab mit einer Metallsäge oder einem Trennschleifer. Nach dem Versiegeln der Schnittstellen durch das beigelegte Zink-Alu Spray (25), treibe die Kunststoff-Rohrstopfen (21) in die Geländerstäbe von unten hinein.



---

Bohre im Anschluss mit dem beiliegendem Bohrer Ø5 mm (28) in jede Kunststoffkappe ungefähr mittig ein Loch. Werden die Löcher nicht gebohrt, können bei Minustemperaturen durch Gefrieren von Regenwasser Schäden an Geländerstab und Handlaufhalter entstehen.



# Montageanleitung Außentreppe Scarvo

## 5) Montage

### Schritt 13

Schiebe nun das Abschlussrohr (17) oben auf das Zentral-Standrohr und befestige dieses mit den Gewindestiften (5) (Bild 1). Anschließend klemme die Ronde (2) oben auf das Abschlussrohr (Bild 2).

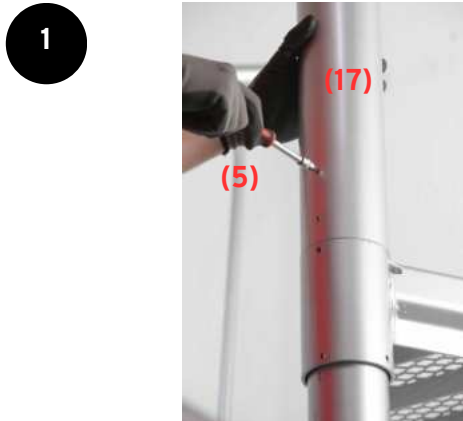

### Schritt 14

Die Stufen, das Podest und das Abschlussrohr werden nun noch zusätzlich mit Spannhülsen (10) gesichert. Bohre dafür durch die vorgesehenen Löcher in den Stufen mit dem Bohrer ein  $\varnothing 5$  mm Loch in das Zentral-Standrohr und treibe die Spannhülse ein.







# Montageanleitung Außentreppe Scarvo

## 5) Montage

### Schritt 15 (Stahl)

Nachdem du die Stufen, das Podest und das Abschlussrohr gesichert hast, wird nun das Geländer an dem Podest wie folgt montiert:

1. Löcher für die Sockel (8) vorbohren (Bild 1).
2. Mit dem Gewindebohrer (26) ein Gewinde in die Löcher schneiden.
3. Sechskantschraube (29) in den Sockel stecken und anschließend in die präparierten Löcher schrauben (Bild 2).
4. Geländerstäbe (16) mit dem Gewindestift befestigen.
5. Handlaufhalter (11) und Geländerstab (16) mit der Halbrundkopf-Schraube (12) verschrauben (Bild 3).

**Bitte achte darauf, dass die Kröpfung der Handlaufhalter nicht nach außen, sondern zur Podest-Innenseite zeigen.**

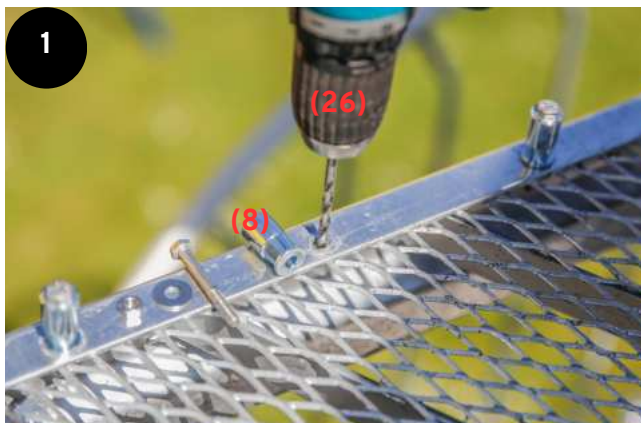

3





# Montageanleitung Außentreppe Scarvo

## 5) Montage

### Schritt 15 (WPC)

Nachdem du die Stufen, das Podest und das Abschlussrohr gesichert hast, wird nun das Geländer an dem Podest wie folgt montiert:

1. Löcher für die Sockel (8) vorbohren, 2 cm vom Rand (Bild 1).
2. Mit dem Gewindebohrer (26) ein Gewinde in die Löcher schneiden.
3. Sechskantschraube (29) in den Sockel stecken und anschließend in die präparierten Löcher schrauben (Bild 2).
4. Geländerstäbe (16) mit dem Gewindestift befestigen.
5. Handlaufhalter (11) und Geländerstab (16) mit der Halbrundkopf-Schraube (12) verschrauben (Bild 3).

**Bitte achte darauf, dass die Kröpfung der Handlaufhalter nicht nach außen, sondern zur Podest-Innenseite zeigt.**





# Montageanleitung Außentreppe Scarvo

## 5) Montage

### Schritt 16

Befestige nun den Handlauf. Als erstes bohre ein Ø5 mm Loch in das Abschlussrohr und schneide dort mit dem beigelegten Gewindebohrer (26) ein Gewinde (Bild 1). Stecke die Sechskantschraube (30) durch den Universalanschluss (15) und schraube diese in das vorgeschrittene Gewinde (Bild 2).

Bohre ein 4 mm Loch durch Handlauf (14) und Universalanschluss (15) und verschraube diese mithilfe der mitgelieferten Linsenkopfschraube (12).



Bitte achte darauf, dass der Podesthandlauf (14) an der angrenzenden Wand oder dem angrenzenden Geländer befestigt wird. Bitte kontrolliere sämtliche Schraubverbindungen an der Treppe und ziehe diese gegebenenfalls nach.



# Montageanleitung Außentreppe Scarvo

## 5) Montage

### Schritt 17

Besprühe alle Stellen, an denen du die Spannhülsen eingetrieben hast bzw. die Gewindestifte eingedreht wurden, mit dem mitgelieferten Zinkspray (25). Überschüssige Verzinkungsreste auf den Gittern der Stufen können einfach mit einem Handfeger entfernt werden.



## Daniel Gruppe GmbH

Daimlerstraße 17

32312 Lübbecke

Telefon 0 57 41 / 34 80 -40

E-Mail [info@scalant.de](mailto:info@scalant.de)



# Instructions external staircase Scarvo

## 1) Required preliminary work

The foundation specifications correspond to normal ground conditions with natural soil.

Concrete material: Bn25

Frost-free foundation (approx. 80 cm) on natural soil.

### Foundation dimensions:

	<b>Ø 130</b>	<b>Ø 160</b>	<b>Ø 180</b>	<b>Ø 225</b>
<b>S</b>	40x40x80 cm	40x40x80 cm	40x40x80 cm	40x40x80 cm
<b>M</b>	55x55x80 cm	55x55x80 cm	55x55x80 cm	55x55x80 cm















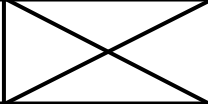



### Tools for installing the outside staircase:

- (Impact) drill, cordless screwdriver
- Screwdriver (Torx)
- Allen wrench (e.g. Inbus) 3 mm, 4 mm, 5 mm
- Tape measure, calculator
- Hammer, combination pliers
- Screwdriver size 10 mm
- Spirit level
- Hacksaw
- Ladder



# Instructions external staircase Scarvo

















## 2) Scarvo Outside Staircase parts list

#	Designation	Technical information	Illustration	
			Standard	premium
1.	Base plate with pipe sleeve			
2.	Round blank			
3.	Curved railing rod			
4.1.	Screw A2 semicircular head	6x25 mm		
4.2.	Countersunk screw	M6x16 mm		
5.	Grub screw	M8x8 mm		
6.	Handrail connector			
7.	Railing foot			
8.	Base for platform rod			
9.	Central support pipe			
10.	Clamping sleeve A2			
11.	Handrail holder			
12.	Screw A2 pan head	4,8x13 mm		
13.	Grub screw	M6x5 mm		
14.	Platform handrail			



# Instructions external staircase Scarvo

## 2) Scarvo Outside Staircase parts list





#	Designation	Technical information	Illustration	
			Standard	premium
15.	Universal connection			
16.	Straight railing rod			
17.	End pipe top			
18.	Platforms			
19.	Steps			
20.	Screw A2 pan countersunk	4,8x16 mm		
21.	Railing rod pipe stopper	Ø20 mm		
22.	Handrail pipe elbow segment	Ø40 mm		
23.	Handrail pipe end plug	Ø40 mm		
24.	Bit	TORX 25		
25.	Zinc aluminum spray	400 ml		
26.	Screw tap	M6 mm		
27.	Cable tie	2,6x100 mm		
28.	Spiral drill	Ø 4 mm Ø 5 mm		





# Instructions external staircase Scarvo

## 2) Scarvo Outside Staircase parts list

#	Designation	Technical information	Illustration	
			Standard	premium
29.	Hexagon screw A2	Stahl: M6x35 mm WPC: M6x60 mm		
30.	Hexagon screw A2	M6x50 mm		
31.	Grub screw	10x8 mm		
32.	Support pipe adapter			





# Instructions external staircase Scarvo

## 3) Calculation of step spacing

The step height must be calculated individually due to the different story heights. Measure story height H from the ground to the upper edge of the floor of the ceiling opening. Divide (:) story height H by the number of steps + platform.

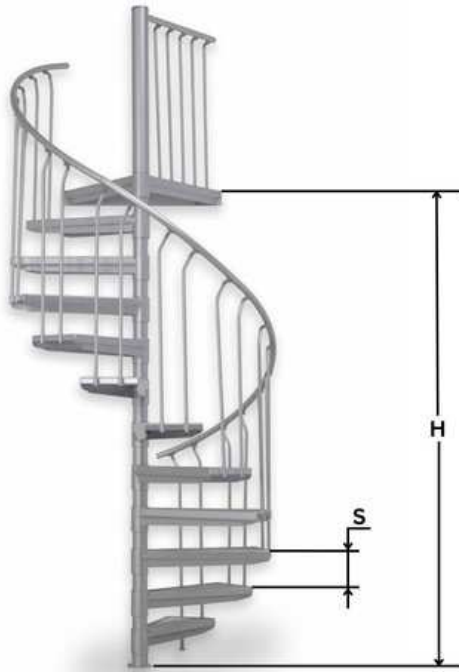

### Example:

$$S = \frac{H}{\text{Number of steps} + \text{Number of platforms}}$$

$$S = \frac{252}{11 \text{ steps} + 1 \text{ platform}}$$

$$S = 21 \text{ cm}$$



The fixing material for assembling the platform to the building and fastening the base plate to the ground is not included.

Please check all screw connections on the spiral staircase at regular intervals.

**No liability is accepted for damage caused by improper assembly.**



# Instructions external staircase Scarvo

## 4) Assembly note for staircases of 15 steps or more

For stair heights over 284 cm, the support pipe is lengthened to the required height using a standpipe extension and firmly fastened using the supplied grub screws (31). The upper end of the support pipe extension is cut off 16-70 cm above the platform. This protrusion is required for fastening the end pipe (17). The rest of the standpipe extension can be disposed of.

For diameters of 130-180 cm, the support pipe is brought to the required height with an additional standpipe (9) from 21 steps or more. The standpipe adapter (32) is used to connect the two support pipes and fastened tightly using the supplied grub screws (31). The support pipe extension is cut off 16-70 cm above the platform. This protrusion is required for fastening the end pipe (17). The rest of the support pipe can be disposed of.

Note: Space for the handrail

Please note that our staircase systems have a flush handrail to the steps, meaning the handrail touches the house wall when the staircase makes a complete turn.

To prevent this, the distance of the support pipe from the wall must be extended by an additional 5-6 cm. Our developed platform adapter can be used for this purpose.

If a building project has an extension to a balcony, for example, there is no need for a platform adapter at any stair height.



# Instructions external staircase Scarvo

## 5) Assembly

### Step 1

Start by pouring the foundation. You will find the dimensions of the foundation for your staircase in the table above (page 21).

To pour the foundation at the correct distance from the wall, use the dimensions for your diameter from the table.

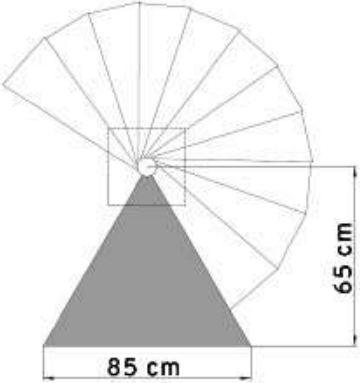
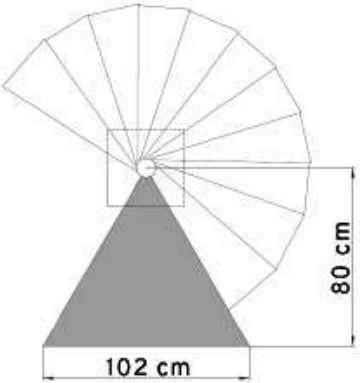
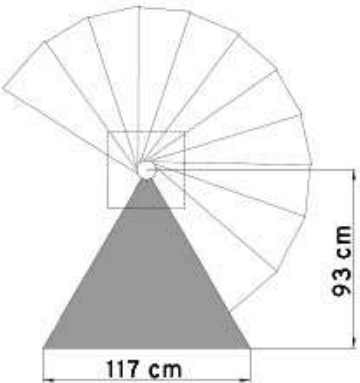
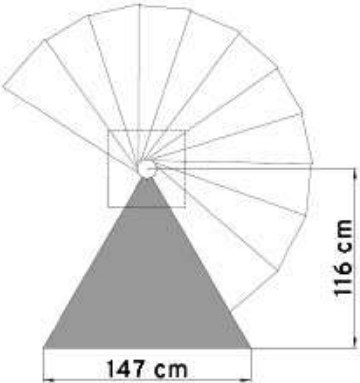
<b>Ø 130 cm</b>	<b>Ø 160 cm</b>
	
<b>Ø 180 cm</b>	<b>Ø 225 cm</b>
	



# Instructions external staircase Scarvo

## 5) Assembly

### Step 2

First the base plate is assembled. To drill the holes in the right places, place the base plate (1) on the foundation and trace the holes marked there with a pencil (fig. 1). When aligning the base plate, make sure the distance to the wall is correct. The table has the correct distances (Page 27).



### Step 3

In the second step, the base plate (1) must be fixed to the foundation (fig. 1). Then place the central support pipe (9) on the base plate attached to the ground and secure it with the supplied grub screws (31) (fig. 2).

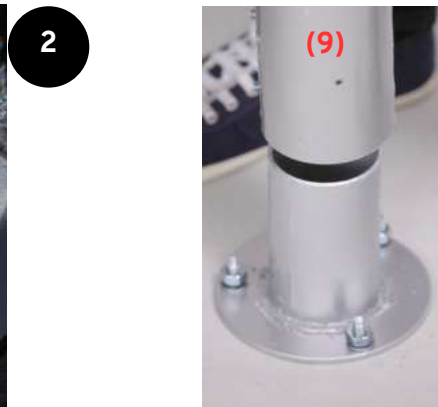



# Instructions external staircase Scarvo

## 5) Assembly

### Step 4

When the central support pipe is in place, you can start inserting the steps (19). To do this, simply slide the steps onto the support pipe on top of each other (fig. 1). To ensure better stability, use an aid such as a square timber and place the first step on top of it (fig. 2).

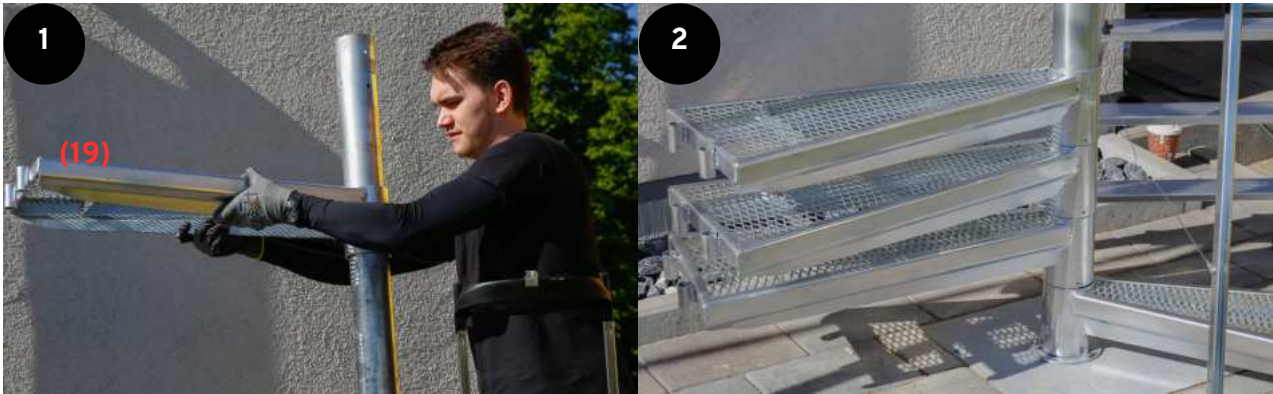

### Step 5

Once all the steps have been inserted, the platform (18) can be mounted on the central support pipe. To do so, align the platform flush with the top edge of the finished floor and screw it to the wall (fig. 1). Then align the platform with a spirit level and fasten it to the central support tube. Use the supplied grub screws (5) (fig. 2). Please note that you have to use at least 10x60 mm key screws for a wooden ceiling and heavy-duty dowels for a concrete ceiling.







# Instructions external staircase Scarvo

## 5) Assembly

### Step 6

The individual step distances then have to be marked and the steps aligned. Orientation lines make it easier to align the steps at a later point. The step distance can be easily calculated:  $\text{Story height } H / (11 \text{ steps} + 1 \text{ platform})$ . Fastening a tape measure to the support pipe makes this much easier (fig. 1). Start with the first step from the top. Let the steps to overlap by 1 cm at the end of the step. Fasten the steps with the grub screws (5) (fig. 2). Do this for all steps.



### Step 7

Now first insert the rear railing rods (3) into the railing holders at the end of the step (fig. 1). First fasten the rods with the grub screws (13) (fig. 2). The curve of the rods points in the opposite direction (seen from bottom to top).





# Instructions external staircase Scarvo

## 5) Assembly

### Step 8

Now insert the front railing rods, letting them protrude approx. 13 cm downwards. Now attach the railing foot (7) to the first railing rod (the railing foot does not need to be assembled on the Scarvo S).

### Step 9

Screw the sections of the handrail holder (11) together with the screw (4). Then attach the handrail holder to the railing rods.



### Step 10

Now place the curved handrail pipe segments (22) on the handrail holders and fasten them temporarily with the supplied cable ties (27) (fig. 1). Start from the bottom. Join the handrail segments together using the handrail connector (6) (Fig. 2).

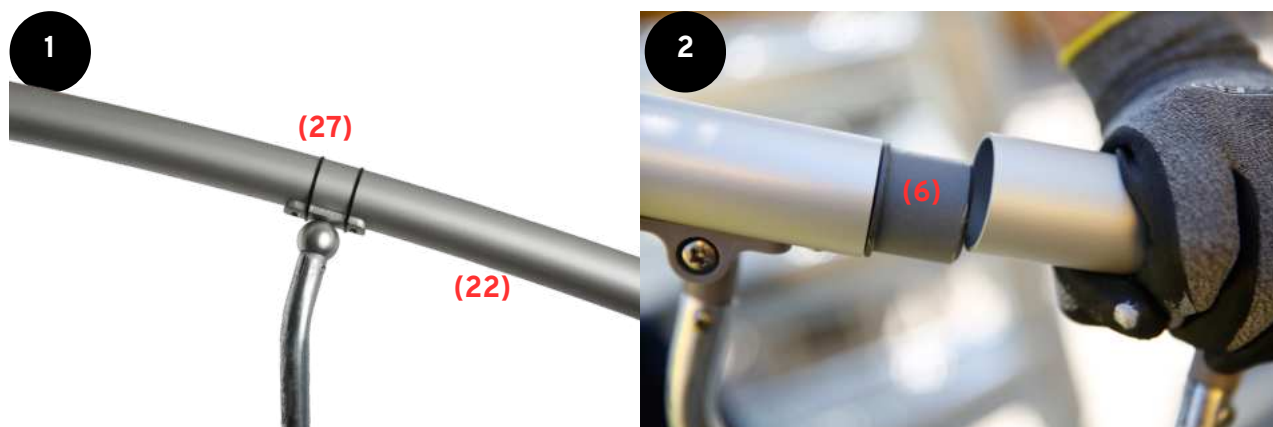



# Instructions external staircase Scarvo

## 5) Assembly

Now align the tabs parallel to the handrail by turning the ball into the rod. The angle of the tab can be changed by turning the rod (fig. 3).

**Important: Check the rods are vertical using a spirit level (fig. 4).**

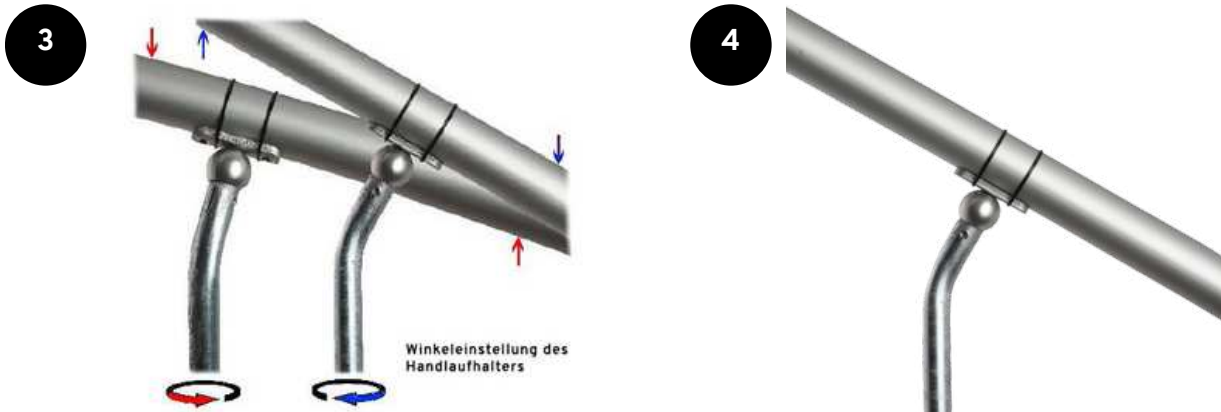

When these are aligned, screw the bracket to the railing rod using the flathead screw (12).

In the next step, mark the holes with a pencil and drill them into the handrail using the supplied  $\text{Ø}4$  mm (28) drill bit. Then take the countersunk screws (20) and screw the handrail holder to the handrail pipe (Fig. 5).







# Instructions external staircase Scarvo

## 5) Assembly

### Step 11

Once the handrails have been fastened, remove the cable ties and tighten the grub screws holding the railing rods at the step ends (fig. 1).



### Step 12

Shorten the railing rod protruding downwards using a hacksaw or an angle grinder. After sealing the interfaces with the enclosed zinc aluminum spray (25), drive the plastic pipe stoppers (21) into the railing rods from below.



---

Then drill a hole roughly in the center of each plastic cap using the supplied Ø5 mm drill bit (28). If the holes are not drilled, freezing rainwater can damage the railing rods and handrail holders in sub-zero temperatures.



# Instructions external staircase Scarvo

## 5) Assembly

### Step 13

Now slide the end pipe (17) onto the top of the central support pipe and secure it with the grub screws (5) (fig. 1). Then clamp the round blank (2) onto the top of the end pipe (fig. 2).

1

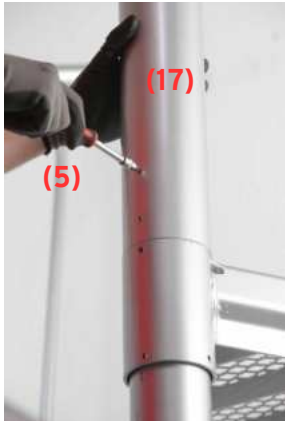

2



### Step 14

Now also secure steps, the platform and the end tube with clamping sleeves (10). To do this, drill a Ø5 mm hole in the central upright support pipe through the holes provided in the steps using the drill and drive in the clamping sleeve.

1

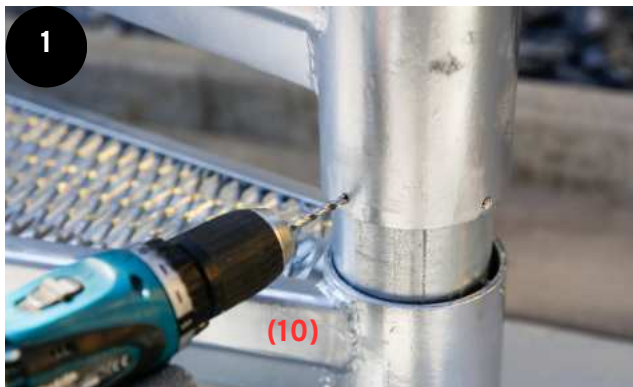

2





# Instructions external staircase Scarvo

## 5) Assembly

### Step 15 (steel)

After you have secured the steps, the platform and the end pipe, fasten the railing to the platform as follows:

1. Drill the holes for the bases (8) in advance (fig. 1).
2. Cut a thread in the holes using the screw tap (26).
3. Insert the hexagon screw (29) into the base and then screw it into the prepared holes (fig. 2).
4. Fix the railing rods (16) with the grub screw.
5. Screw the handrail holder (11) and railing rod (16) together with the semicircular head screw (12) (fig. 3).

**Please make sure that the curve of the handrail holder does not point outwards, but towards the inside of the platform.**

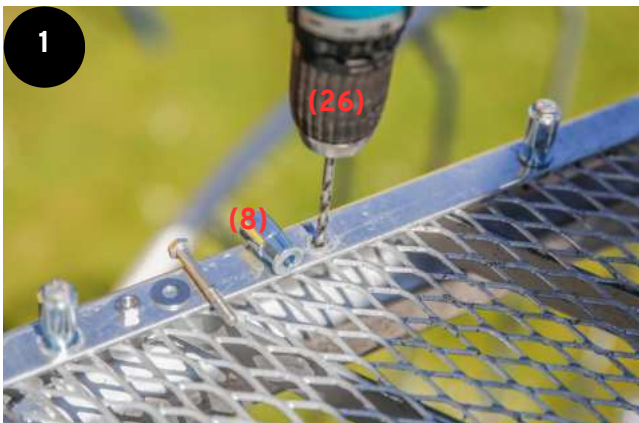

3





# Instructions external staircase Scarvo

## 5) Assembly

### Step 15 (WPC)

After you have secured the steps, the platform and the end pipe, fasten the railing to the platform as follows:

1. Drill the holes for the bases (8) 2 cm from the edge in advance (fig. 1)
2. Cut a thread in the holes using the screw tap (26).
3. Insert the hexagon screw (29) into the base and then screw it into the prepared holes (fig. 2).
4. Fix the railing rods (16) with the grub screw.
5. Screw the handrail holder (11) and railing rod (16) together with the semicircular head screw (12) (fig. 3).

**Please make sure that the curve of the handrail holder does not point outwards, but towards the inside of the platform.**

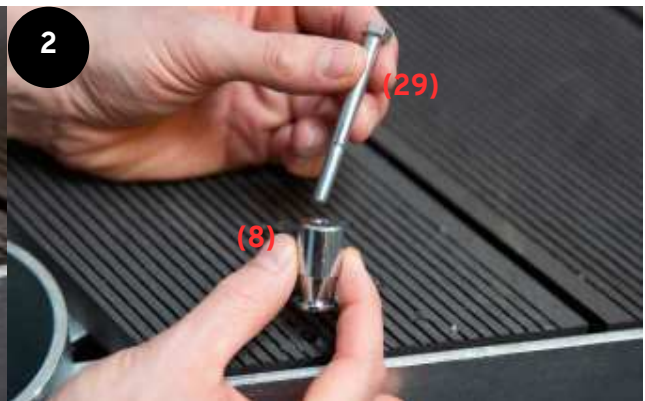



# Instructions external staircase Scarvo

## 5) Assembly

### Step 16

Now fasten the handrail. First, drill a  $\varnothing 5$  mm hole in the end pipe and cut a thread there using the supplied screw tap (26) (fig. 1). Insert the hexagon screw (30) through the universal connection (15) and screw it into the pre-cut thread (fig. 2).

Drill a 4 mm hole through the handrail (14) and universal connection (15) and screw them together using the supplied pan head screw (12).



Please make sure that the platform handrail (14) is attached to the adjacent wall or railing. Please check all screw connections on the stairs and tighten if needed.





# Instructions external staircase Scarvo

## 5) Assembly

### Step 17

Spray all points where you have driven in the clamping sleeves or where the grub screws have been screwed in with the supplied zinc spray (25). Excess zinc residue on the step grates can be easily removed with a hand brush.



**SCALANT is a brand of**  
**Daniel Gruppe GmbH**  
Daimlerstraße 17  
32312 Lübbecke  
E-mail [info@scalant.eu](mailto:info@scalant.eu)



# Instructions d'installation escalier extérieur Scarvo

## 1) Préparatifs nécessaires

Les indications concernant la réalisation des fondations sont valables pour un sol normal, non remanié.

Qualité du béton : Bn25

Fondations hors gel (env. 80 cm de profondeur) sur sol non remanié.

### Dimensions des fondations :

	<b>Ø 130</b>	<b>Ø 160</b>	<b>Ø 180</b>	<b>Ø 225</b>
<b>S</b>	40x40x80 cm	40x40x80 cm	40x40x80 cm	40x40x80 cm
<b>M</b>	55x55x80 cm	55x55x80 cm	55x55x80 cm	55x55x80 cm

### Outillage nécessaire au montage de l'escalier extérieur :

- Outillage nécessaire au montage de l'escalier extérieur :
- Perceuse à percussion, visseuse sans fil
- Tournevis (Torx)
- Clés pour vis à six pans creux (type Inbus, p. ex.) 3 mm, 4 mm, 5 mm
- Mètre ruban, calculatrice
- Marteau, pince universelle
- Clé de serrage 10 mm
- Niveau à bulle
- Scie à métaux
- Escabeau



# Instructions d'installation escalier extérieur Scarvo













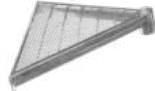

## 2) Liste des pièces pour l'escalier extérieur Scarvo

#	Désignation	Infos techniques	Illustration	
			Standard	Premium
1.	Pied avec emmanchement pour tube			
2.	Couvercle			
3.	Main-courante coudée			
4.1.	Vis à tête demi-ronde A2	6x25 mm		
4.2.	Vis à tête fraisée	M6x16 mm		
5.	Vis sans tête	M8x8 mm		
6.	Raccord pour main-courante			
7.	Pied de garde-corps			
8.	Douille support de palier			
9.	Colonne centrale verticale			
10.	Goupille de serrage A2			
11.	Support de main-courante			
12.	Vis à tête bombée A2	4,8x13 mm		
13.	Vis sans tête	M6x5 mm		
14.	Main-courante de palier			









## 2) Liste des pièces pour l'escalier extérieur Scarvo

#	Désignation	Infos techniques	Illustration	
			Standard	Premium
15.	Connecteur universel			
16.	Main-courante droite			
17.	Tube de fermeture haut			
18.	Palier avec grille métallique			
19.	Marche avec grille métallique			
20.	Vis à tête fraisée A2	4,8x16 mm		
21.	Embout pour tube de main-courante	Ø20 mm		
22.	Section de main-courante cintrée	Ø40 mm		
23.	Bouchon pour tube de main-courante	Ø40 mm		
24.	Embout	TORX 25		
25.	Pulvérisateur Alu-Zinc	400 ml		
26.	Taraud	M6 mm		
27.	Collier de serrage	2,6x100 mm		



## 2) Liste des pièces pour l'escalier extérieur Scarvo

#	Désignation	Infos techniques	Illustration	
			Standard	Premium
28.	Foret hélicoïdal	Ø 4 mm Ø 5 mm		
29.	Vis à tête hexagonale A2	Stahl: M6x35 mm WPC: M6x60 mm		
30.	Vis à tête hexagonale A2	M6x50 mm		
31.	Vis sans tête	10x8 mm		
32.	Adaptateur pour colonne centrale			



# Instructions d'installation escalier extérieur Scarvo

## 3) Calcul des hauteurs de marche

La hauteur des niveaux d'un bâtiment étant spécifique, la hauteur des marches doit être calculée individuellement. Mesurer la hauteur de niveau H entre le sol et le bord supérieur de l'ouverture pratiquée dans le plafond. Diviser la hauteur H par le nombre de marches + palier.

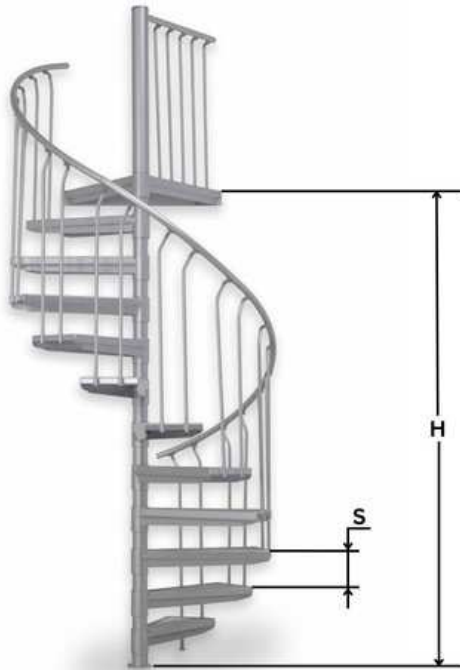

### Exemple:

$$S = \frac{H}{\text{Number of steps} + \text{Nombre de paliers}}$$

$$S = \frac{252}{11 \text{ marches} + 1 \text{ palier}}$$

$$S = 21 \text{ cm}$$



Les fournitures nécessaires pour fixer le palier au bâtiment et pour fixer la plaque de base dans le sol ne sont pas incluses.

Contrôler régulièrement tous les raccords vissés présents sur l'escalier hélicoïdal.

**Nous refusons toute mise en cause de notre responsabilité en cas de dommages causés par un montage non conforme.**



## 4) Conseils de montage pour un escalier de plus de 15 marches

Pour un escalier de hauteur supérieure à 284 cm, amener la colonne centrale à la hauteur requise au moyen d'un tube de rallonge avant de la fixer fermement à l'aide des vis sans tête fournies (31). Couper l'extrémité supérieure de la rallonge de colonne centrale à 16-70 cm au-dessus du palier. Ce dépassement permet de fixer le tube de fermeture (17). Le reste du tube de rallonge ne sera pas utilisé.

Pour un escalier de diamètre 130-180 cm comportant 21 marches et plus, amener la colonne centrale à la hauteur requise au moyen d'une autre colonne centrale (9). Pour relier les deux colonnes, utiliser un adaptateur (32) et visser les deux éléments à l'aide des vis sans tête fournies (31). Couper l'extrémité supérieure de la colonne centrale de prolongement à 16-70 cm au-dessus du palier. Ce dépassement permet de fixer le tube de fermeture (17). Le reste de la colonne de prolongement ne sera pas utilisé.

Remarque : Emplacement de la main-courante

Nos systèmes d'escaliers comportent une main-courante fixée à fleur de marches. Par conséquent, la main-courante est directement en contact avec le mur du bâtiment lorsque l'escalier fait un tour complet.

Pour l'éviter, il est nécessaire d'augmenter la distance entre la colonne centrale et le mur de 5-6 cm supplémentaires. Notre adaptateur de palier spécialement conçu peut être utilisé dans ce cas.

Si le projet comporte l'extension d'un balcon par exemple, l'adaptateur de palier n'est pas nécessaire, quelle que soit la hauteur de l'escalier.



## 5) Montage

### Étape 1

Commencer par couler la fondation. Le tableau (page 39) indique les dimensions de la fondation à réaliser en fonction du type d'escalier. Pour couler la fondation à bonne distance du mur du bâtiment, utiliser les dimensions correspondant au diamètre d'escalier fournies dans le tableau.

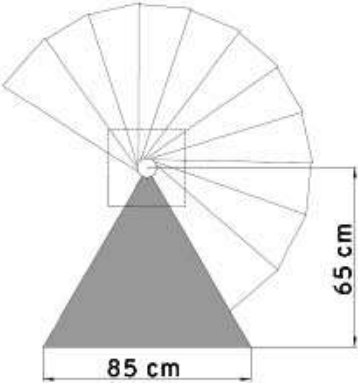
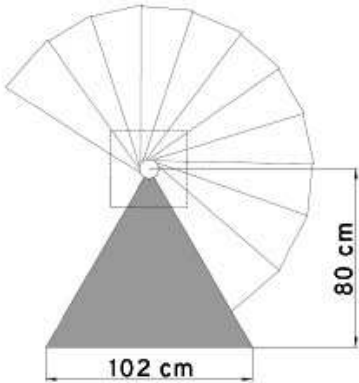
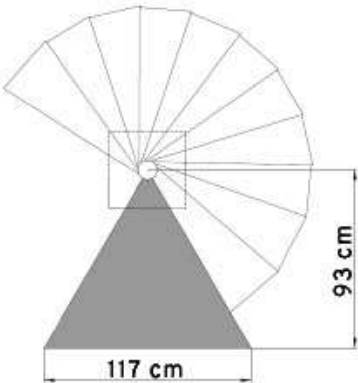
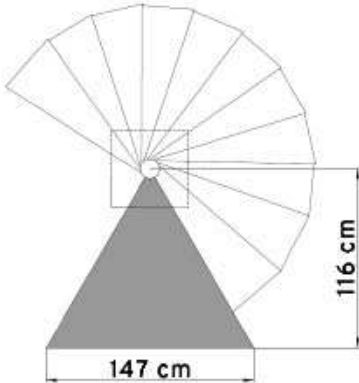
Ø 130 cm	Ø 160 cm
	
Ø 180 cm	Ø 225 cm
	



## 5) Montage

### Étape 2

Fixer la plaque de base. Afin de percer les trous aux bons endroits, positionner la plaque de base (1) sur la fondation et marquer les trous au crayon aux emplacements prévus (figure 1). Pour aligner la plaque de base, vérifier la distance par rapport au mur du bâtiment. Le tableau indique les distances adaptées (Page 45).



### Étape 3

La deuxième étape consiste à fixer la plaque de base (1) à la fondation (figure 1). Ensuite, positionner la colonne centrale verticale (9) sur la plaque de base fixée au sol et la fixer avec les vis sans tête fournies (31) (figure 2).

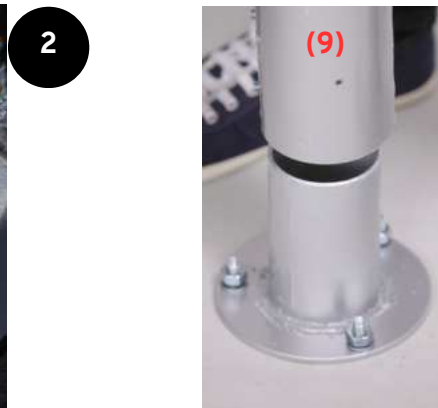





## 5) Montage

### Étape 4

Lorsque la colonne centrale est en place, commencer à enfiler les marches (19). Faire glisser les marches sur la colonne centrale les unes au-dessus des autres (figure 1). Pour assurer une meilleure stabilité, utiliser par exemple une pièce de bois équarrie sur laquelle vous placerez la première marche (figure 2).

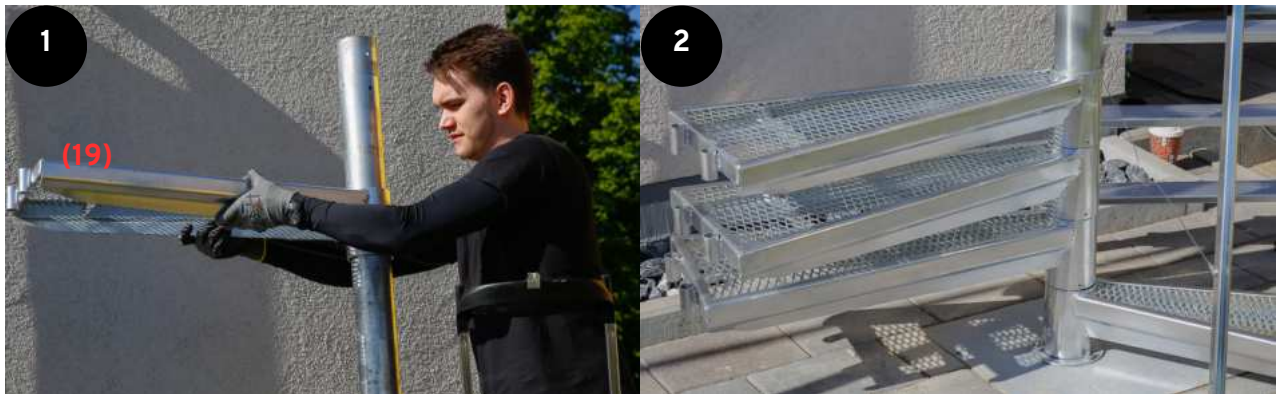

### Étape 5

Quand toutes les marches sont positionnées, monter le palier (18) sur la colonne centrale. Pour ce faire, aligner le palier au ras du bord supérieur du plancher fini, avant de le visser au mur (figure 1). Ensuite, aligner le palier avec un niveau à bulle avant de le fixer à la colonne centrale. Utiliser pour cela les vis sans têtes (5) fournies (figure 2). Vous devez utiliser des vis d'au moins 10x60 mm pour la fixation dans un plafond en bois et des chevilles haute résistance pour la fixation dans une dalle en béton.





# Instructions d'installation escalier extérieur Scarvo

## 5) Montage

### Étape 6

Ensuite, marquer l'écartement entre les marches et aligner les marches. Les repères d'orientation facilitent l'alignement ultérieur des marches. L'écartement entre les marches peut être déterminé facilement : Hauteur H / (11 marches + 1 palier). Pour faciliter l'opération, fixer un mètre ruban sur la colonne centrale (figure 1). Commencer par la première marche en partant du haut. Les marches doivent se chevaucher sur 1 cm en bout de marche. Fixer les marches à l'aide des vis sans tête (5) (figure 2). Procéder de la même manière pour toutes les marches.



### Étape 7

Commencer par insérer les tiges arrière du garde-corps (3) dans les supports de garde-corps positionnés en bout de marche (figure 1). Fixer ensuite les tiges à l'aide des vis sans tête (13) (figure 2). Le déport des tiges pointe dans la direction opposée au sens de marche (vu de bas en haut).

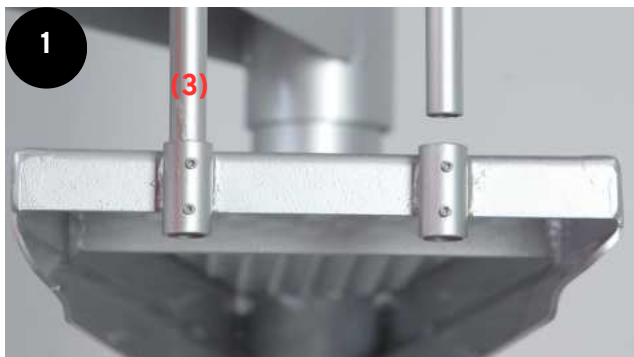



## 5) Montage

### Étape 8

Insérer maintenant les tiges avant du garde-corps et en les laissant dépasser d'environ 13 cm vers le bas. Fixer ensuite le pied de garde-corps (7) à la première tige de garde-corps (sur la version Scarvo S, ne pas monter le pied de garde-corps).

### Étape 9

Fixer les éléments des supports de main-courante (11) avec les vis (4). Ensuite, insérer les supports de main-courante sur les tiges du garde-corps.



### Étape 10

Placer maintenant les sections de main-courante cintrées (22) sur les supports de main-courante avant de les fixer provisoirement avec les colliers de serrage (27) fournis (figure 1). Commencer par le bas. Utiliser les raccords pour main-courante (6) pour assembler les sections de main-courante (figure 2).

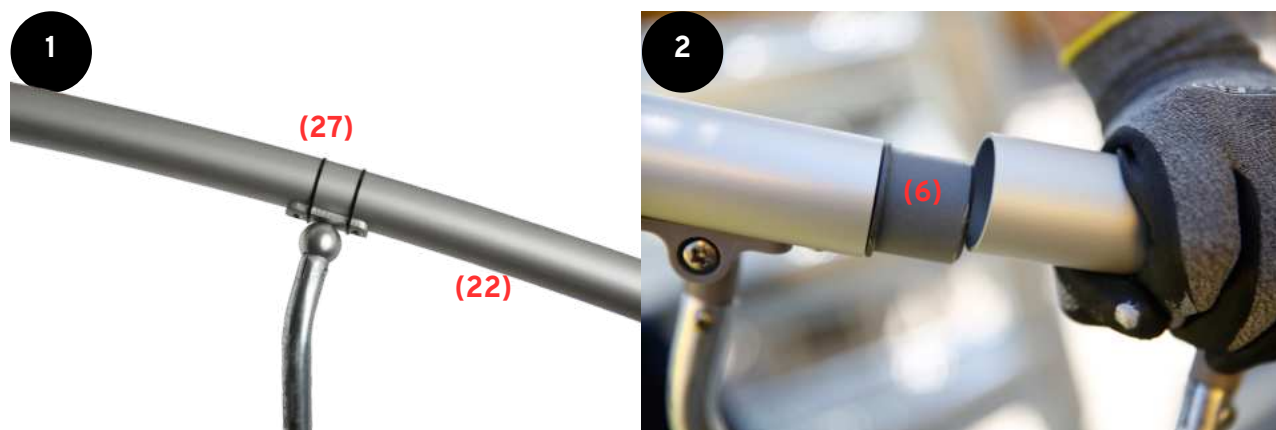



# Instructions d'installation escalier extérieur Scarvo

## 5) Montage

Orienter les pattes parallèlement à la main-courante en tournant la sphère dans la tige. Tourner la tige permet de modifier l'angle de la patte (figure 3).

**Important :** Utiliser un niveau à bulle pour aligner verticalement les tiges de garde-corps (figure 4).

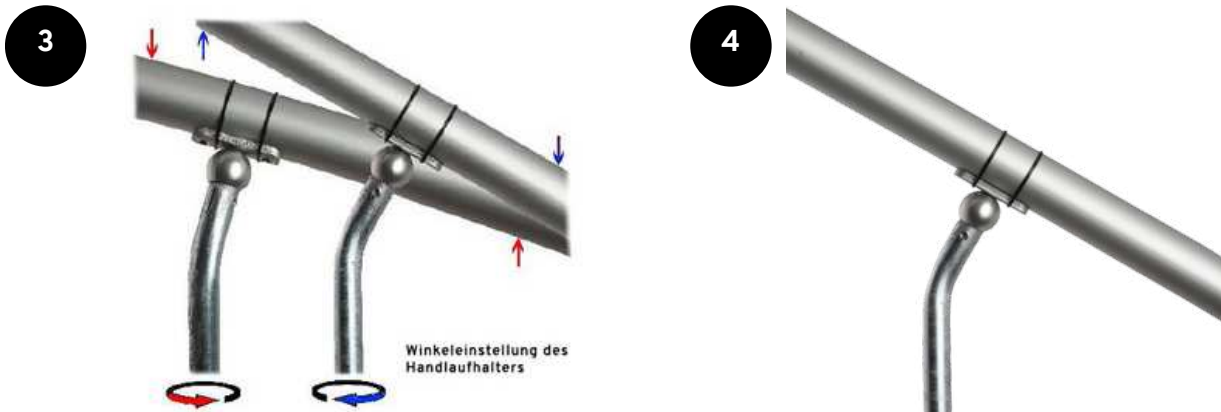

Une fois la verticalité contrôlée, visser les supports aux tiges de garde-corps à l'aide des vis à tête plate (12).

Marquer les trous à l'aide d'un crayon et percer la main-courante à l'aide du foret de Ø 4 mm (28) fourni. Ensuite, prendre les vis à tête fraisée (20) pour visser le support de main-courante au tube de main-courante (figure 5).





## 5) Montage

### Étape 11

Une fois la main-courante vissée, enlever les colliers de serrage-câbles et serrer les vis sans tête pour fixer les tiges de garde-corps en bout de marche (figure 1).



### Étape 12

Raccourcir la partie des tiges de garde-corps qui dépasse vers le bas à l'aide d'une scie à métaux ou d'une meuleuse de découpe. Après avoir protégé les coupes à l'aide du pulvérisateur zinc-aluminium (25) fourni, insérer les bouchons en plastique (21) dans les tiges de garde-corps, par le bas.



Ensuite, percer un trou à peu près au centre de chaque bouchon en plastique à l'aide du foret de Ø 5 mm fourni (28). Si les trous ne sont pas percés, l'eau de pluie peut s'accumuler dans les tiges de garde-corps et les supports de main-courante et les endommager en cas de gel.





# Instructions d'installation escalier extérieur Scarvo

## 5) Montage

### Étape 13

Insérer maintenant le tube de fermeture (17) sur le haut de la colonne centrale avant de le fixer à l'aide des vis sans tête (5) (figure 1). Ensuite, placer le couvercle (2) sur l'extrémité du tube de fermeture (figure 2).

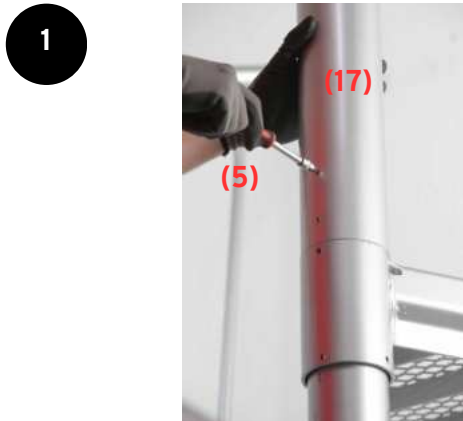

### Étape 14

Il convient à présent de parfaire la fixation des marches, du palier et du tube de fermeture à l'aide de manchons de serrage (10). Percer un trou de  $\varnothing$  5 mm dans la colonne centrale à travers les trous prévus dans les marches à l'aide du foret, puis insérer la goupille de serrage.







## 5) Montage

### Étape 15 (acier)

Après avoir fixé les marches, le palier et le tube de fermeture, il convient d'assembler le garde-corps sur le palier :

1. Pré-percer des trous pour les douilles (8) (figure 1).
2. Fileter les trous percés à l'aide du taraud (26).
3. Insérer les vis à tête hexagonale (29) dans les douilles avant de les visser dans les trous préparés (figure 2).
4. Fixer les tiges du garde-corps (16) à l'aide de vis sans tête.
5. Visser les supports de main-courante (11) et les tiges de garde-corps (16) avec des vis à tête demi-ronde (12) (figure 3).

**Vérifier que le coude de fixation à la main-courante ne pointe pas vers l'extérieur, mais bien vers l'intérieur du palier.**

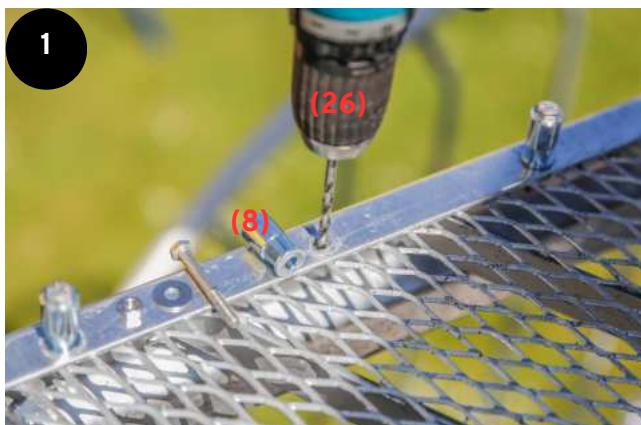

3





## 5) Montage

### Étape 15 (WPC)

Après avoir fixé les marches, le palier et le tube de fermeture, il convient d'assembler le garde-corps sur le palier :

1. Pré-percer des trous pour les douilles (8), à 2 cm du bord (figure 1).
2. Fileter les trous percés à l'aide du taraud (26).
3. Insérer les vis à tête hexagonale (29) dans les douilles avant de les visser dans les trous préparés (figure 2).
4. Fixer les tiges du garde-corps (16) à l'aide de vis sans tête.
5. Visser les supports de main-courante (11) et les tiges de garde-corps (16) avec des vis à tête demi-ronde (12) (figure 3).

**Vérifier que le coude de fixation à la main-courante ne pointe pas vers l'extérieur, mais bien vers l'intérieur du palier.**

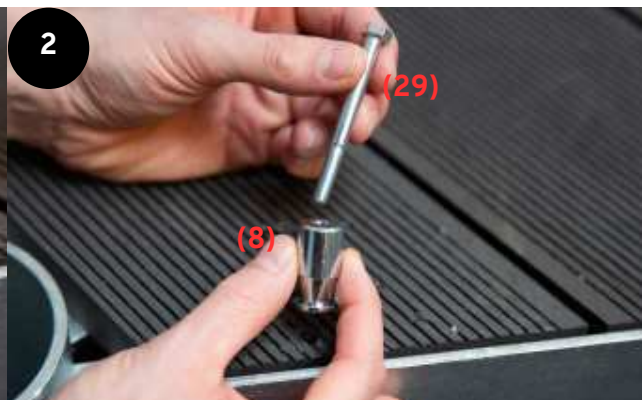



## 5) Montage

### Étape 16

À présent, fixer la main-courante. Commencer par percer un trou de  $\varnothing$  5 mm dans le tube de fermeture et réaliser un filetage à l'aide du taraud (26) fourni (figure 1). Insérer la vis à tête hexagonale (30) à travers le connecteur universel (15) pour la visser dans le filetage préparé dans le tube (figure 2).

Percer un trou de  $\varnothing$  4 mm dans la main-courante (14) et le connecteur universel (15) et assembler ces éléments à l'aide de la vis à tête bombée (12) fournie.

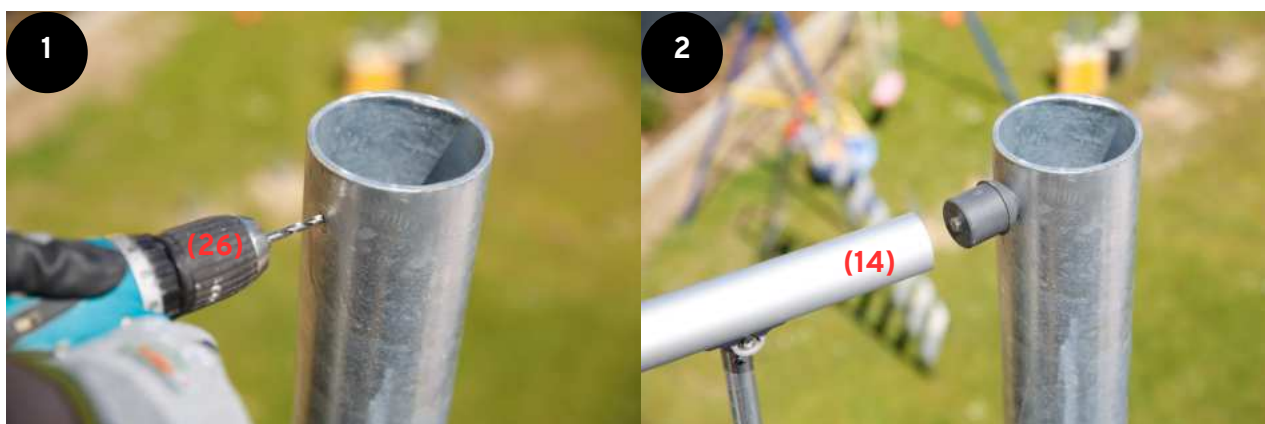

La main-courante du palier (14) doit être fixée au mur ou au garde-corps. Contrôler tous les raccords vissés de l'escalier et resserrer si nécessaire.



## 5) Montage

### Étape 17

À l'aide du pulvérisateur (25) fourni, appliquer un film de zinc-aluminium à chaque point d'insertion d'une goupille ou d'une vis sans tête. Les éventuels résidus de zinc pulvérisés sur les grilles des marches peuvent être facilement éliminés à l'aide d'une brosse à main.



**SCALANT une marque de la société**

**Daniel Gruppe GmbH**

Daimlerstraße 17

D-32312 Lübbecke

Téléphone +33 644 68 71 11

E-mail [info@scalant.fr](mailto:info@scalant.fr)



## 1) Trabajos previos necesarios

Las especificaciones de los cimientos corresponden a las condiciones normales del terreno con suelo natural.

Material de hormigón: Bn25

Cimentación libre de heladas (aprox. 80 cm) sobre suelo natural.

### Dimensiones de los cimientos:

	<b>Ø 130</b>	<b>Ø 160</b>	<b>Ø 180</b>	<b>Ø 225</b>
<b>S</b>	40x40x80 cm	40x40x80 cm	40x40x80 cm	40x40x80 cm
<b>M</b>	55x55x80 cm	55x55x80 cm	55x55x80 cm	55x55x80 cm

### Accesorios para la instalación de la escalera exterior:

- Taladro (percutor), atornillador de batería
- Destornillador (Torx)
- Llave hexagonal interior (por ejemplo, llave Allen) de 3 mm, 4 mm, 5 mm
- Cinta métrica, calculadora de bolsillo
- Martillo, alicates
- Llave SW10 mm
- Nivel de burbuja
- Sierra de metal
- Escalera















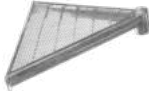

## 2) Lista de piezas - escalera exterior Scarvo

#	Denominación	Información técnica	Ilustración	
			Estándar	Premium
1.	Placa base con manguito de tubo			
2.	Tapa redonda			
3.	Barandilla acodada			
4.1.	Tornillo A2 de cabeza semicircular	6x25 mm		
4.2.	Tornillo avellanado	M6x16 mm		
5.	Tornillo prisionero	M8x8 mm		
6.	Conector de pasamanos			
7.	Pie de barandilla			
8.	Base para varilla de rellano			
9.	Tubo de soporte central			
10.	Manguito de sujeción A2			
11.	Soporte de pasamanos			
12.	Tornillo A2 de cabeza lenticular	4,8x13 mm		
13.	Tornillo prisionero	M6x5 mm		





## 2) Lista de piezas - escalera exterior Scarvo

#	Denominación	Información técnica	Ilustración	
			Estándar	Premium
14.	Pasamanos de rellano			
15.	Conector universal			
16.	Barandilla recta			
17.	Tubo de extremo superior			
18.	Rellanos con rejilla encajable			
19.	Escalones con rejilla encajable			
20.	Tornillo A2 de cabeza avellanada	4,8x16 mm		
21.	Tapón para barra de barandilla	Ø20 mm		
22.	Segmento de tubo de pasamanos	Ø40 mm		
23.	Tapón final de tubo de pasamanos	Ø40 mm		
24.	Punta	TORX 25		
25.	Aerosol de zinc-aluminio	400 ml		
26.	Terraaja	M6 mm		



## 2) Lista de piezas - escalera exterior Scarvo

#	Denominación	Información técnica	Ilustración	
			Estándar	Premium
27.	Brida para cables	2,6x100 mm		
28.	Broca espiral	Ø 4 mm Ø 5 mm		
29.	Tornillo hexagonal A2	Stahl: M6x35 mm WPC: M6x60 mm		
30.	Tornillo hexagonal A2	M6x50 mm		
31.	Tornillo prisionero	10x8 mm		
32.	Adaptador para tubo de soporte			



## 3) Cálculo de la distancia entre escalones

Debido a las diferentes alturas de los pisos, la altura del escalón debe calcularse individualmente. Mida la altura del piso H desde el suelo hasta el borde superior del suelo de la abertura del techo. Divida (:) la altura del piso H por el número de peldaños + rellano.

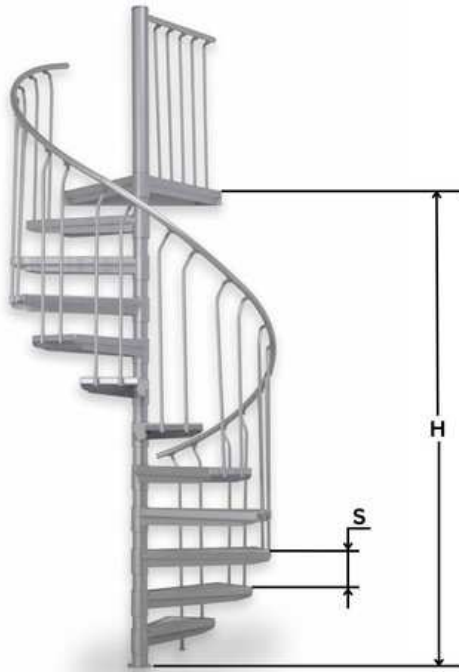

### Ejemplo:

$$S = \frac{H}{\text{Número de escalones} + \text{Número de rellanos}}$$

$$S = \frac{252}{11 \text{ Escalones} + 1 \text{ rellano}}$$

$$S = 21 \text{ cm}$$



El material de fijación para montar el rellano en el edificio y para montar la placa base en el suelo no está incluido.

Compruebe periódicamente todas las uniones atornilladas de la escalera de caracol.

**No se acepta ninguna responsabilidad por daños causados por una instalación incorrecta.**



### 4) Instrucciones de montaje para escaleras a partir de 15 escalones

Para alturas de escalera superiores a 284 cm, el tubo de soporte se lleva a la altura requerida utilizando una extensión de tubo y se atornilla firmemente con los tornillos prisioneros (31) suministrados. El extremo superior de la prolongación del tubo de soporte se corta 16-70 cm por encima del rellano. Este saliente es necesario para fijar el tubo terminal (17). El resto del tubo de prolongación puede desecharse.

Para diámetros de 130-180 cm, a partir de 21 escalones el tubo de soporte vertical se ajusta a la altura necesaria mediante otro tubo adicional (9). El adaptador de tubo de soporte (32) se utiliza para conectar los dos tubos verticales y se atornilla firmemente con los tornillos prisioneros (31) suministrados. El extremo superior del tubo de soporte de prolongación se corta entre 16 y 70 cm por encima del rellano. Este saliente es necesario para fijar el tubo terminal (17). El resto del tubo de soporte puede desecharse.

Nota: Espacio para la barandilla

Tenga en cuenta que nuestros sistemas de escaleras tienen un pasamanos enrasado con los peldaños y, por lo tanto, el pasamanos enlaza directamente con la pared de la casa cuando la escalera realiza un giro completo.

Para evitar esto, la distancia del tubo de soporte vertical desde la pared puede ampliarse 5-6 cm más. Para ello, se puede utilizar el adaptador de rellano desarrollado por nosotros.

En el caso de un proyecto de construcción con ampliación a un balcón, por ejemplo, el adaptador de rellano no es necesario para ninguna altura de escalera.



## 5) Montaje

### Paso 1

Empiece por echar los cimientos. Encontrará las dimensiones de los cimientos de su escalera en la tabla anterior (pág. 57).

Para verter los cimientos a la distancia correcta de la pared, tome las dimensiones de su diámetro de la tabla.

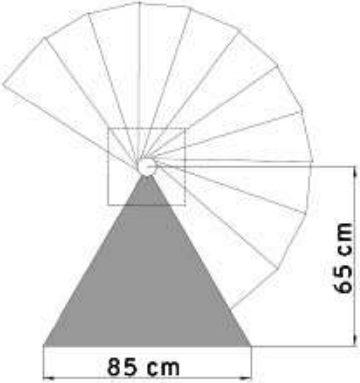
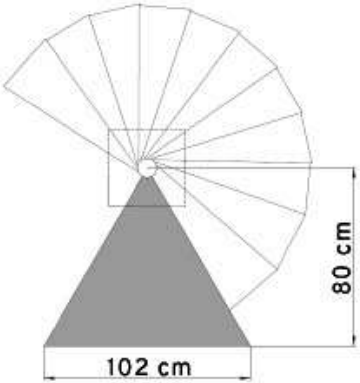
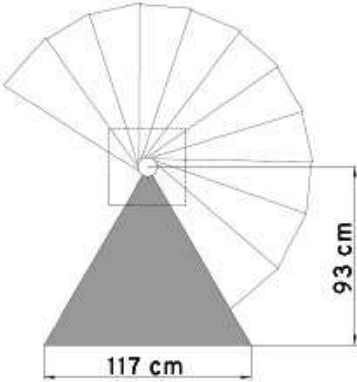
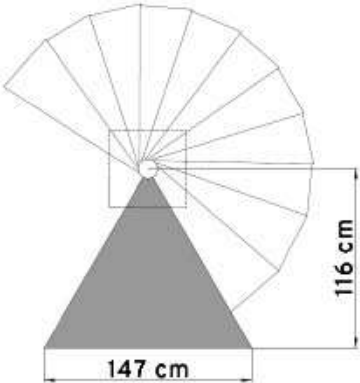
<b>Ø 130 cm</b>	<b>Ø 160 cm</b>
	
<b>Ø 180 cm</b>	<b>Ø 225 cm</b>
	



## 5) Montaje

### Paso 2

En primer lugar se monta la placa base. Para taladrar los orificios en los lugares correctos, debe colocarse la placa base (1) sobre los cimientos y marcar los orificios predefinidos con un lápiz (fig. 1). Al alinear la placa base, debe respetarse la distancia correcta a la pared. Consulte la tabla para conocer las distancias adecuadas (pág. 63).



### Paso 3

En el segundo paso, la placa base (1) debe fijarse a los cimientos (fig. 1). A continuación, coloque el tubo de soporte central (9) sobre la placa base fijada al suelo y fíjelo con los tornillos prisioneros (31) que se suministran (fig. 2).

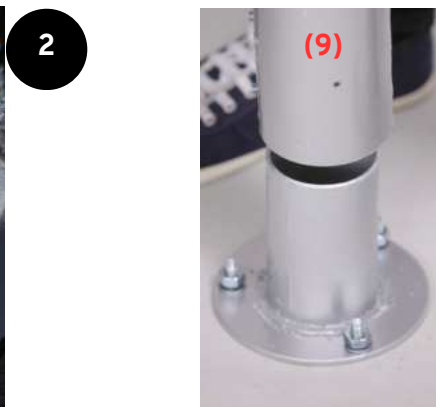





## 5) Montaje

### Paso 4

Una vez colocado el tubo de soporte central, puede empezar a colocar los peldaños (19) de abajo arriba. Para ello, basta con deslizar los peldaños unos sobre otros en el tubo de soporte (fig. 1). Para garantizar una mayor estabilidad, utilice un accesorio como, por ejemplo, un cuadradillo de madera y coloque el primer peldaño sobre el cuadradillo (fig. 2).

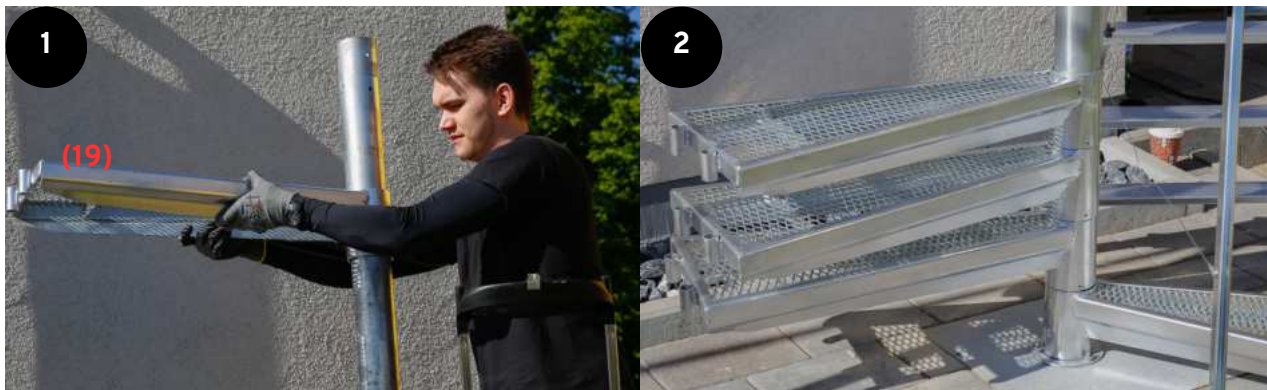

### Paso 5

Una vez insertados todos los peldaños, se puede montar el rellano (18) en el tubo de soporte central. Para ello, alinee el rellano a ras con el borde superior del suelo acabado y atorníllelo a la pared (fig. 1). A continuación, nivele el rellano con un nivel de burbuja y fíjelo al tubo de soporte central. Utilice para ello los tornillos prisioneros (5) suministrados (fig. 2). Tenga en cuenta que debe utilizar como mínimo tornillos de 10x60 mm para un techo de madera y tacos para cargas pesadas para un techo de hormigón.





## 5) Montaje

### Paso 6

A continuación, hay que marcar las distancias entre los escalones y alinearlos. Las líneas de orientación facilitan la posterior alineación de los peldaños. La distancia entre peldaños se puede determinar fácilmente:  $\text{Altura del piso } H / (11 \text{ peldaños} + 1 \text{ rellano})$ . Fijar una cinta métrica al tubo de soporte facilita mucho el trabajo (fig. 1). Comience con el primer escalón desde arriba. Deje que los peldaños se solapen 1 cm al final del peldaño. Fije los peldaños con los tornillos prisioneros (5) (fig. 2). Realice este paso con todos los peldaños.



### Paso 7

A continuación, introduzca primero las varillas de la barandilla trasera (3) en los soportes para la barandilla situados al final del escalón (fig. 1). Fije primero las varillas con los tornillos prisioneros (13) (fig. 2). La curva de las varillas apunta en sentido contrario al de marcha (visto de abajo hacia arriba).

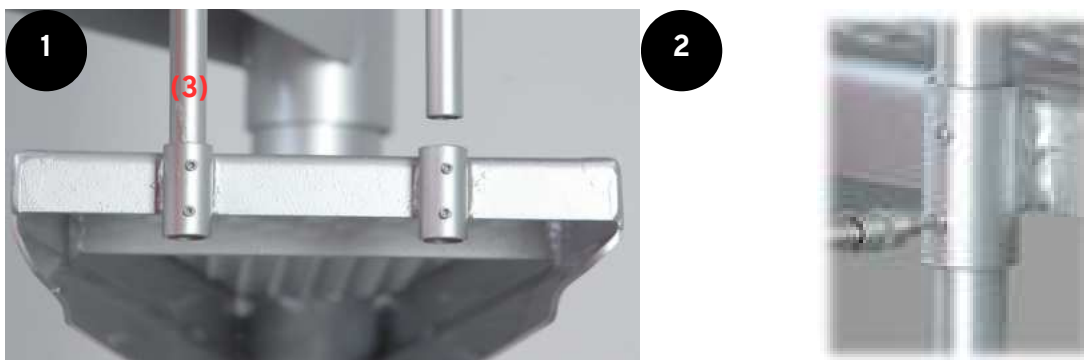



## 5) Montaje

### Paso 8

Introduzca ahora las varillas de la barandilla delantera y deje que sobresalgan unos 13 cm hacia abajo. Fije ahora el pie de la barandilla (7) en la primera varilla de la barandilla (no es necesario montar el pie de la barandilla en la Scarvo S).

### Paso 9

Atornille las piezas del soporte del pasamanos (11) con el tornillo (4). A continuación, fije el soporte del pasamanos a las varillas de la barandilla.



### Paso 10

Coloque ahora los segmentos de tubo del pasamanos (22) en los soportes del pasamanos y fíjelos provisionalmente con las bridas para cables (27) suministradas (fig. 1). Empiece por la parte inferior. Una los segmentos del pasamanos con los conectores (6) (fig. 2).

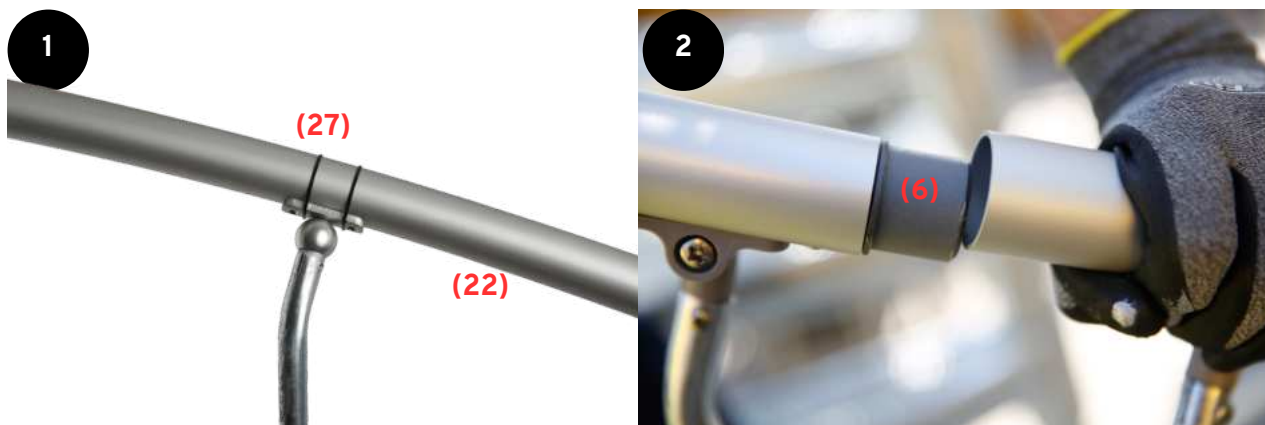



## 5) Montaje

Ahora alinee las lengüetas en paralelo al pasamanos girando la bola en la varilla. El ángulo de la lengüeta puede modificarse girando la varilla (fig. 3).

**Importante:** Compruebe la verticalidad de las varillas utilizando un nivel de burbuja (fig. 4).

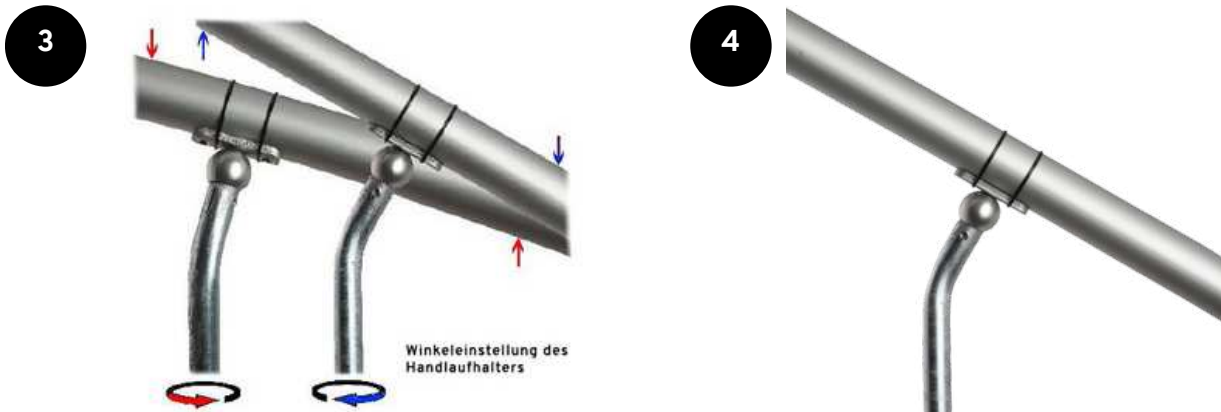

Una vez alineados, atornille el soporte a la varilla de la barandilla con el tornillo de cabeza plana (12).

En el siguiente paso, marque los orificios con un lápiz y taládrelos en el pasamanos con la broca de Ø4 mm (28) suministrada. A continuación, tome los tornillos avellanados (20) y atornille el soporte del pasamanos al tubo del pasamanos (fig. 5).





## 5) Montaje

### Paso 11

Una vez atornillados los pasamanos, se retiran las bridas para cables y se aprietan los tornillos prisioneros que sujetan las varillas de la barandilla en los extremos de los peldaños (fig. 1).

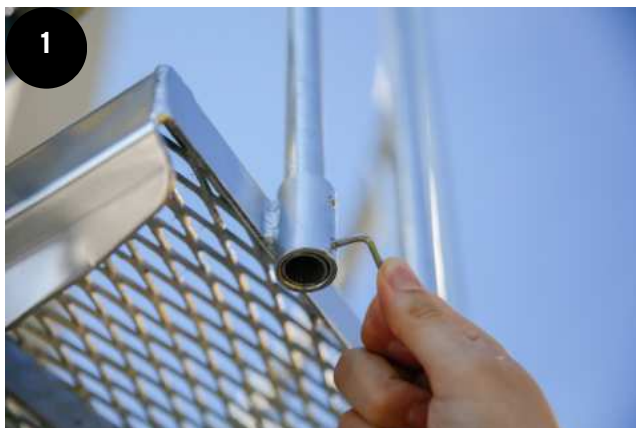

### Paso 12

Recorte la varilla de la barandilla que sobresale hacia abajo utilizando una sierra para metales o una amoladora de corte. Después de sellar los puntos de corte con el spray de zinc-aluminio (25) adjunto, introduzca desde abajo los tapones de tubo de plástico (21) en las varillas de la barandilla.



---

A continuación, taladre un orificio aproximadamente en el centro de cada tapa de plástico con la broca de Ø5 mm (28) incluida. Si no se taladran los agujeros, el agua de lluvia helada puede dañar las varillas de la barandilla y los soportes del pasamanos a temperaturas bajo cero.





## 5) Montaje

### Paso 13

Coloque ahora el tubo terminal (17) en la parte superior del tubo de soporte central y fíjelo con los tornillos prisioneros (5) (fig. 1). A continuación, fije la tapa redonda (2) en la parte superior del tubo terminal (fig. 2).

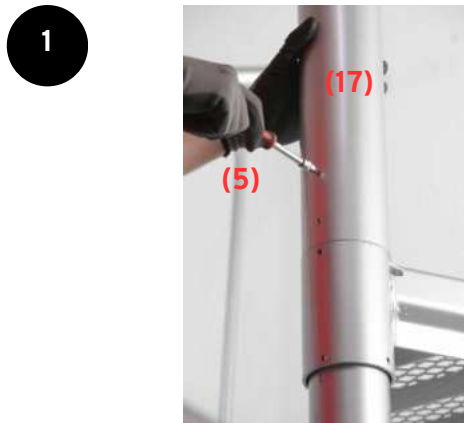

### Paso 14

Los peldaños, el rellano y el tubo terminal se fijan ahora adicionalmente con manguitos de sujeción (10). Para ello, taladre con el taladro un agujero de Ø5 mm en el tubo de soporte central a través de los agujeros previstos en los peldaños e introduzca el manguito de sujeción.







## 5) Montaje

### Paso 15 (acero)

Una vez fijados los peldaños, el rellano y el tubo terminal, la barandilla se monta en el rellano de la siguiente manera:

1. Taladre previamente los orificios para los zócalos (8) (fig. 1).
2. Aterraje una rosca en los orificios utilizando la terraaja (26).
3. Inserte el tornillo de cabeza hexagonal (29) en el zócalo y, a continuación, atorníllelo en los orificios preparados (fig. 2).
4. Fije las varillas de la barandilla (16) con el tornillo prisionero.
5. Atornille el soporte de la barandilla (11) y la varilla de la barandilla (16) con el tornillo de cabeza semirredonda (12) (fig. 3).

**Asegúrese de que la curva del soporte del pasamanos no apunte hacia afuera, sino hacia el interior del rellano.**

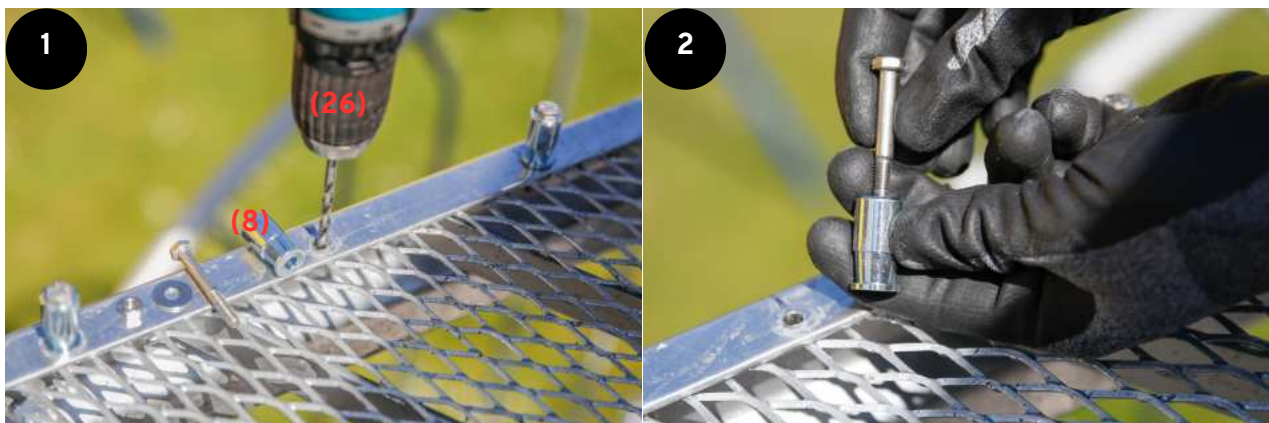

3





## 5) Montaje

### Paso 15 (WPC)

Una vez fijados los peldaños, el rellano y el tubo terminal, la barandilla se monta en el rellano de la siguiente manera:

1. Pretaladre los agujeros para el zócalo (8), a 2 cm del borde (fig. 1).
2. Aterraje una rosca en los orificios utilizando la terraja (26).
3. Inserte el tornillo de cabeza hexagonal (29) en el zócalo y, a continuación, atorníllelo en los orificios preparados (fig. 2).
4. Fije las varillas de la barandilla (16) con el tornillo prisionero.
5. Atornille el soporte de la barandilla (11) y la varilla de la barandilla (16) con el tornillo de cabeza semirredonda (12) (fig. 3).

**Asegúrese de que la curva del soporte del pasamanos no apunte hacia afuera, sino hacia el interior del rellano.**

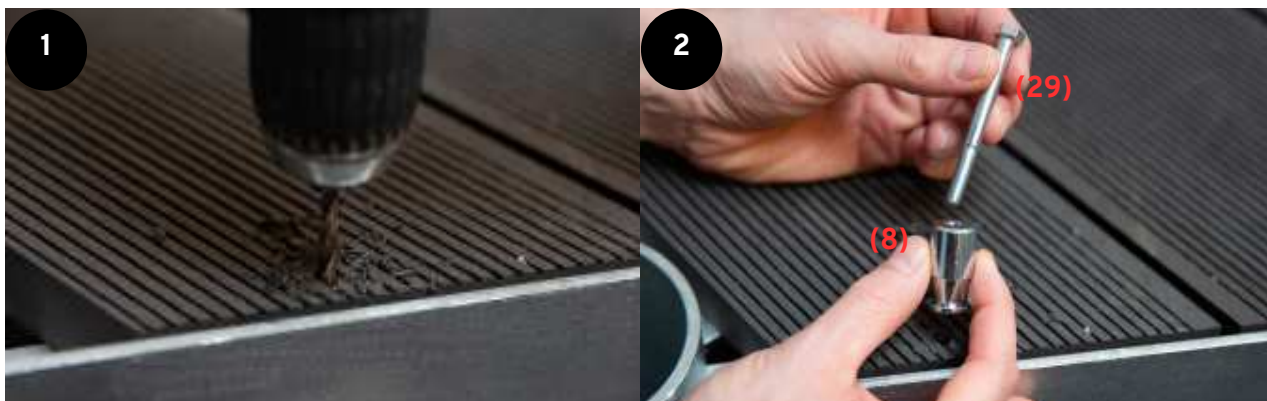



## 5) Montaje

### Paso 16

Ahora fije el pasamanos. En primer lugar, taladre un orificio de  $\varnothing 5$  mm en el tubo terminal y corte allí una rosca con la terraja (26) suministrada (fig. 1). Introduzca el tornillo de cabeza hexagonal (30) a través de la conexión universal (15) y atorníllelo en la rosca previamente creada (fig. 2).

Taladre un orificio de 4 mm a través del pasamanos (14) y la conexión universal (15) y atorníllelos con el tornillo de cabeza lenticular (12) suministrado.

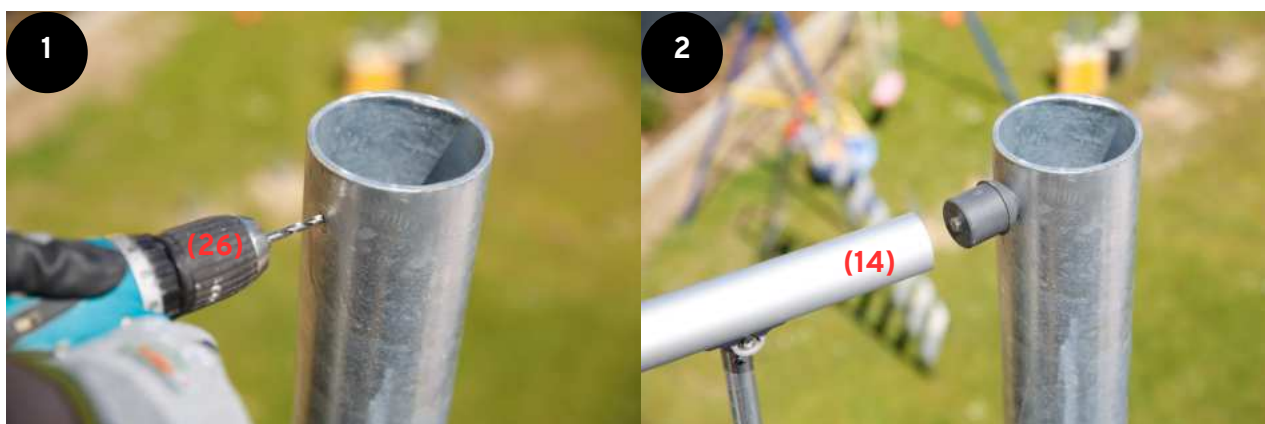

Asegúrese de que el pasamanos del rellano (14) está fijado a la pared o barandilla adyacentes. Compruebe todas las uniones atornilladas de la escalera y apriételas si es necesario.



## 5) Montaje

### Paso 17

Rocíe todas las zonas donde haya introducido los manguitos de sujeción o donde se hayan atornillado los tornillos prisioneros con el spray de zinc (25) suministrado. Los restos de galvanizado sobrantes en las rejillas de los peldaños pueden eliminarse fácilmente con un cepillo de mano.



**SCALANT es una marca de**

**Daniel Gruppe GmbH**

Daimlerstraße 17

32312 Lübbecke (Alemania)

Correo-e [info@scalant.eu](mailto:info@scalant.eu)